

ASRD 14

Three-phase current transformer set

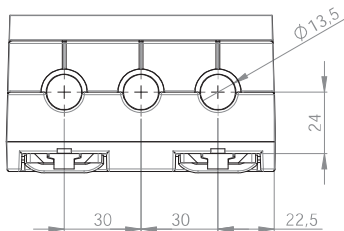

Round conductor 13,5 mm
 Transformer width 105 mm
 Height 90 mm
 Depth 54 mm

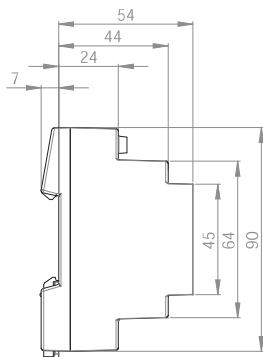
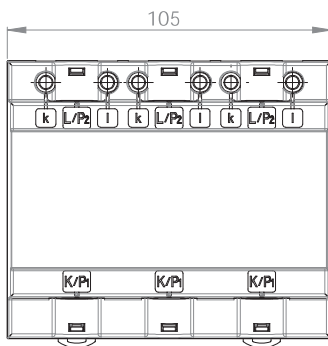

Primary current [A]	Burden [VA]	Secondary current [A] / Class			
		5 A Cl. 1 Art.-no.	5 A Cl. 0,5 Art.-no.	1 A Cl. 1 Art.-no.	1 A Cl. 0,5 Art.-no.
3 x 50	1	96030		96230	
3 x 60	1,25	96032		96232	
3 x 75	1,5	96034		96234	
3 x 80	1,5	96036		96236	
3 x 100	2,5	96038		96238	
3 x 125	2,5	96039	96014	96239	96214
3 x 150	2,5	96040	96017	96240	96217
	3,75	96044		96244	

		Art.-no.
	Snap-on mounting	-
	Sealed shutter	-

ASRD 210.3

Three-phase current transformer set



Round conductor 21,5 mm
 Transformer width 49,6 mm
 Height 156,6 mm
 Depth 103 mm

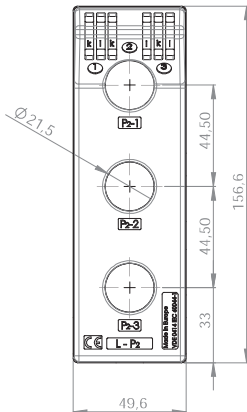
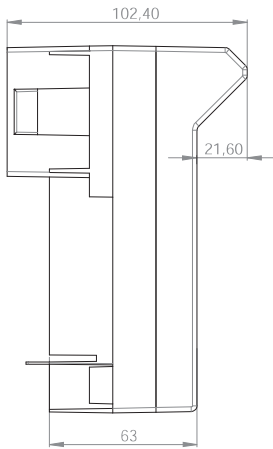
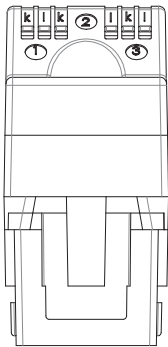

Primary current [A]	Burden [VA]	Secondary current [A] / Class			
		5 A Cl. 1 Art.-no.	5 A Cl. 0,5 Art.-no.	1 A Cl. 1 Art.-no.	1 A Cl. 0,5 Art.-no.
3 x 75	1,25	27703		27803	
	1,5	27704		27804	
3 x 80	1,25	27705		27805	
	1,5	27706		27806	
3 x 100	1,5	27707		27807	
	2,5	27708		27808	
3 x 125	1,5	27709		27809	
	2,5	27710		27810	
	3,75	27711		27811	
3 x 150	1,5	27712		27812	
	2,5	27713	27725	27813	27825
	3,75	27714		27814	
3 x 200	1,5	27715		27815	
	2,5	27716		27816	
	5	27717		27817	
3 x 250	2,5	27718		27818	
	5	27719		27819	

		Art.-no.
	Snap-on mounting	-
	Sealed shutter	-

ASRD 205.37

Three-phase current transformer set



Bus bar 1	20 x 5 mm
Round conductor	18 mm
Transformer width	115 mm
Height	65 mm
Depth	37 mm

Primary current [A]	Burden [VA]	Secondary current [A] / Class	
		5 A Cl. 1 Art.-no.	1 A Cl. 1 Art.-no.
3 x 100	1	D205-010	D205-020
3 x 150	1,25	D205-011	D205-021
3 x 160	1,5	D205-014	D205-024
3 x 200	1,5	D205-012	D205-022
3 x 250	2,5	D205-013	D205-023

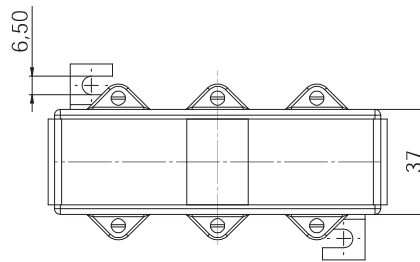
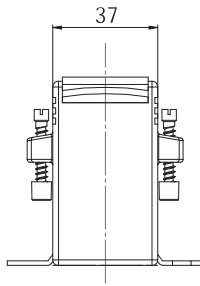
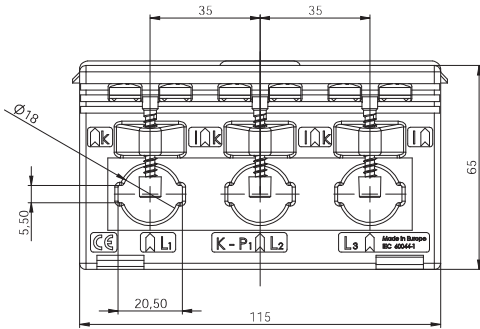

ASRD 310.37

Three-phase current transformer set



Primary current [A]	Burden [VA]	Secondary current [A] / Class	
		5 A Cl. 1 Art.-no.	1 A Cl. 1 Art.-no.
3 x 250	2,5	D310-010	D310-020
3 x 300	3,75	D310-011	D310-021
3 x 400	5	D310-012	D310-022
3 x 500	5	D310-013	D310-023
3 x 600	5	D310-014	D310-024

Bus bar 1 30 x 10 mm
 Round conductor 22 mm
 Transformer width 150 mm
 Height 75 mm
 Depth 37 mm

